

Bacino Tight Radius Bowls

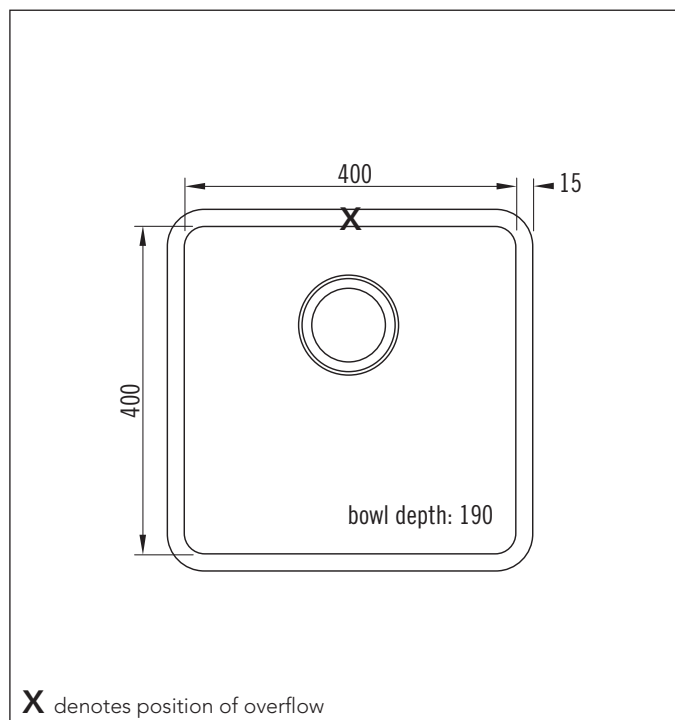

Bacino 442



Code: AQ Bacino 442
Undermount Single Bowl

Size: 400mm w x 400mm d x 190mm bowl depth

Waste outlet position: centred approx. 110mm from rear of bowl

Hole diameter: 87mm

Depression diameter: 114mm

Minimum clearance required in cabinet

Length: 410mm

Depth: 410mm

General rule: Bowl dimension + 10mm

- 1mm thick, 304 18/10 stainless steel
- 25mm tight radius corners
- Complete with 1 strainer waste and overflow
- Sound deadening pad
- 15mm rim

Aquatica Warranty

Aquatica NZ Limited offer, from the date of purchase, a 2 year warranty on handshowers, a 5 year warranty on tapware and accessories and a lifetime warranty on stainless steel sinks.

Aquatica NZ Limited warrants that only high quality workmanship and materials have been employed in the manufacture of its tapware, accessories and stainless steel products. If any faulty workmanship or materials is proven during the warranty period, Aquatica NZ Limited will at its own cost repair, or at its option replace, the faulty product.

The guarantee is non-transferable and proof of purchase is required.

The use of spray or abrasive cleaners of any kind will void the warranty. (Tapware should only be cleaned with a mild detergent and a soft damp cloth).

Failure to use an in-line strainer or filter on lines to tapware incorporating a ceramic cartridge or ceramic disc mechanism may also void the warranty.

Every effort has been made to show the products as they will be sold, however, all models and specifications are subject to change without notice.

Aquatica NZ Limited

9 Saunders Place,
Avondale, Auckland.

Tel: 09-828 2068,

Fax: 09-828 2069

Email: info@aquatica.co.nz

or visit our website:

www.aquatica.co.nz